

FreeStyle™ 5

FreeStyle™ 5 Portable
Oxygen Concentrator
Service Manual



AirSep Corporation • 401 Creekside Drive • Buffalo, NY 14228-2085 USA
Telephone: 716.691.0202 • 24-Hour Fax: 716.691.4141 • www.airsep.com

Expedited Product Warranty Check service is always at your fingertips with AirSep:

http://www.airsep.com/Support/Warranty_Information.aspx

OR

In the US or Canada,
dial 866-873-9277

AirSep® is a registered trademark of AirSep Corporation.



FreeStyle 5™ is a trademark of AirSep Corporation.

Table of Contents

Section 1.0

Introduction

- 1.1 Equipment Provider Responsibility
 - 1.2 Important Notice and Symbol Explanations
 - 1.3 Definitions of Symbols
 - 1.4 FreeStyle 5 Specifications
 - 1.5 FreeStyle 5 Classifications
-

Section 2.0

Operation Check and Test of Oxygen Concentration

- 2.1 Description of Operation
- 2.2 Operation Check
- 2.3 Alarm System
 - 2.3.1 Start-up
 - 2.3.2 Battery Status
 - 2.3.3 Low Battery
 - 2.3.4 Discharged Battery
 - 2.3.5 Battery Charging
 - 2.3.6 Battery Fully Charged
 - 2.3.7 Cannula Disconnect
 - 2.3.8 Performance Warning
 - 2.3.9 FreeStyle 5 Capacity Exceeded
 - 2.3.10 General Malfunction
- 2.4 Oxygen Concentration Test and Specification

Section 3.0

Patient Instructions

- 3.1 General Instructions
 - 3.1.1 Connecting to external Power
 - 3.1.2 Optional AirBelt Battery
- 3.2 Routine Maintenance by the Patient
 - 3.2.1 Cleaning the Air Intake Gross Particle Filter
 - 3.2.2 Alarm/Service Indicator
 - 3.2.3 Usage with Extended Tubing
 - 3.2.4 Usage at Night

Section 4.0

Equipment Provider

Maintenance

- 4.1 Routine Maintenance
 - 4.1.1 Air Intake / Gross Particle Filter
 - 4.1.2 Product Filter Replacement
 - 4.1.3 Compressor Servicing
 - 4.1.4 Recording Maintenance
 - 4.2 Infection Control
 - 4.3 Cleaning and Preparing for New Patient Use
-

Section 5.0

Service

- 5.1 Components
- 5.2 Housing Removal
 - 5.2.1 Removing Front Cover
 - 5.2.2 Removing Back Cover
- 5.3 Internal Battery Replacement
- 5.4 PSA Removal
- 5.5 Compressor Replacement
 - 5.5.1 Compressor Assembly Removal
 - 5.5.2 Compressor Assembly Installation
- 5.6 Product Manifold Replacement
- 5.7 Solenoid Valve Replacement
- 5.8 Adsorbent Bed Replacement
- 5.9 Feed/Waste Manifold Replacement
- 5.10 Measuring System Pressure
- 5.11 Circuit Board Replacement
- 5.12 Motor Controller Board Replacement
- 5.13 Control/Key Panel Replacement
- 5.14 Fan Replacement

Section 6.0

Typical Pressure Profiles

- 6.1 Pressure Profile Quadrant

Section 7.0

Troubleshooting

- 7.1 General Troubleshooting
- 7.2 Troubleshooting Chart

Section 8.0

Recommended Tools

- 8.1 Tools for FreeStyle 5 Service and Maintenance

Appendix

Exploded Drawings

- | | |
|---|-----|
| Figure 1: FreeStyle 5 — Internal Front View | A-1 |
| Figure 2: FreeStyle 5 — Internal Rear View | A-2 |
| Figure 3: FreeStyle 5 — PSA Assembly - Product
Manifold | A-3 |
| Figure 4: FreeStyle 5 — PSA Assembly - Feed/Waste
Manifold | A-4 |

1.0 Introduction

1.1 Equipment Provider Responsibility

All Equipment Providers of the FreeStyle™5 Portable Oxygen Concentrator must assume responsibilities for handling, operational check-out, patient instruction, and maintenance. These responsibilities are outlined below and throughout this manual.





This unit is not to be used for life support. Geriatric, pediatric, or any other patients unable to communicate discomfort while using this unit may require additional monitoring. Patients with hearing and/or sight impairment(s) may need assistance with monitoring alarms.

As an Equipment Provider, you must do all of the following:

- Inspect the condition of each FreeStyle 5 unit immediately upon delivery to your business location. Note any sign of damage, external or internal, on the delivery receipt, and report it directly to both the freight company and AirSep Corporation immediately.
- Check the operation of each FreeStyle 5 unit before delivery to a patient. Always operate the unit for a minimum of 10 minutes, and check that the oxygen concentration level is within specifications, as described in Section 5 of this manual.
- Deliver FreeStyle 5 units only to patients authorized by a physician's prescription. FreeStyle 5 must not be used as a life-supporting device.
- Instruct patients how to use FreeStyle 5 in conjunction with the *Patient Manual*.
- Instruct patients to notify their physicians and/or Equipment Providers if they experience any signs of discomfort.
- Be available to service each patient at any time.
- Maintain FreeStyle 5 in accordance with Section 4.0.
- Repair components and replace parts only as outlined in this manual. Use only AirSep parts for replacement in FreeStyle 5 Oxygen Concentrators.

1.2 Important Notice and Symbol Explanations

As you review both the *FreeStyle 5 Patient Manual* and this *FreeStyle 5 Service Manual*, pay special attention to the WARNING, CAUTION, and NOTE messages. They identify safety guidelines or other important information as follows:

	Warning – Describes a hazard or unsafe practice that if not avoided can result in severe bodily injury, death or property damage
	Caution – Describes a hazard or unsafe practice that if not avoided can result in minor bodily injury or property damage
	Note – Provides information important enough to emphasize or repeat



DO NOT OPERATE THIS EQUIPMENT WITHOUT FIRST READING AND UNDERSTANDING THIS MANUAL. IF YOU ARE UNABLE TO UNDERSTAND THE WARNINGS AND INSTRUCTIONS, CONTACT YOUR EQUIPMENT PROVIDER BEFORE ATTEMPTING TO USE THIS EQUIPMENT; OTHERWISE, INJURY OR DAMAGE MAY RESULT.



Smoking while using oxygen is the number one cause of fire injuries and related deaths. You must follow these safety warnings:

Do not allow smoking, candles, or open flames in the same room with the device or within 5 feet (1.52 meters) of the oxygen-carrying accessories.

Smoking while wearing an oxygen cannula may cause facial burns and possibly death.

Removing the cannula and putting it on bedding, sofas, or other cushion material will cause a flash fire when exposed to a cigarette, heat source, or flame.

If you smoke, these 3 steps may save your life:

turn off the oxygen concentrator, take off the cannula, and leave the room where this device is located.























“No Smoking – Oxygen in Use” signs must be prominently displayed in the home, or where the oxygen concentrator is in use. Patients and their caregivers must be informed about the dangers of smoking in the presence of, or while using, medical oxygen.

1.3 Definitions of Symbols

Symbols are frequently used on equipment and/or the manual in preference to words with the intention of decreasing the possibility of misunderstanding caused by language differences. Symbols can also permit easier comprehension of a concept within a restricted space.

The following table is a list of symbols and definitions used with the FreeStyle 5 Portable Oxygen Concentrator.

Symbol	Description	Symbol	Description
	Warning – Describes a hazard or unsafe practice that if not avoided can result in severe bodily injury, death or property damage		Class II Equipment, double insulated
	Caution – Describes a hazard or unsafe practice that if not avoided can result in minor bodily injury or property damage		Complies with the 93/42/EEC directive drawn up by the approved organization No. 0459
	Note – Provides information important enough to emphasize or repeat		Safety agency for CAN/CSA C22.2 No. 60601-1-08 M90 for medical electrical equipment
	Consult the accompanying documents		Keep unit and accessories dry
	Use no oil or grease		Proper disposal of waste of electrical and electronic equipment required
	No smoking		Do not disassemble
	Type BF equipment		Consult instructions for use
	Fragile - handle with care		Do not expose to open flames
	FAA-Approved POC		This side up
	RTCA DO160 Section 21 Category M Compliant. FAA SFAR 106 requirement		See Instructions

1.4 FreeStyle 5 Specifications

Oxygen Concentration:*	1-5 pulse settings; equivalent to a continuous flow of 90% oxygen +5.5 / -3% Flow Rate Settings: 1 ,2, 3, 4 & 5 LPM (equivalent to continuous flow) Setting 1±15%. Settings 2 through 5±10%
Dimensions:	10.7 in. high x 6.6 in. wide x 4.4 in. deep (27.2 cm high x 16.8 cm wide x 11.2 cm deep)
Weight:	6.2 lb (2.8 kg); 1.8 lb (.8 kg) optional AirBelt
Power:	AC Power Supply: Input: 100-240VAC, 50-60Hz, 2A Output: 15V DC Power Supply: Input: 12VDC-24VDC, 15A max Output: 15V, 8A max
Battery duration (Rechargeable lithium Battery)	5 LPM – 1 hour; 4 LPM – 1 hour, 15 minutes; 3 LPM – 1 hour, 30 minutes; 2 LPM – 2 hours; 1 LPM – 3 hours Optional AirBelt when combined with the internal battery: 5 LPM – 2 hours, 30 minutes; 4 LPM – 3 hours; 3 LPM – 3 hours, 30 minutes; 2 LPM – 4 hours, 30 minutes; 1 LPM – 7 hours
Battery recharge time:	3 hours, 15 minutes; optional AirBelt: 3 hours, 30 minutes
Initial startup time	2 minutes
Battery cycle life:	Approximately 300 cycles, then 80% capacity or below.
Audible alarms and pulse visual indicators:	Start-up – audible and visual (GREEN indicator light); Pulse flow – visual (GREEN indicator light); Battery condition – battery level (GREEN indicator lights); Battery Low – audible and visual (YELLOW alarm light); Battery shutdown – audible and visual (YELLOW alarm light); Cannula disconnect- audible and visual (YELLOW alarm light); System overdraw – audible and visual (YELLOW alarm light); General malfunction – audible and visual (RED alarm light).
**Temperature range:	Operational temperature: 41°F to 104°F (5°C to 40°C) (Up to 95% RH (non-condensing)) Storage temperature: -4°F to 140°F (-20°C to 60°C)
**Max Operational Altitude:	up to 12,000 ft (3,657.6 m) (483mmHg) Higher altitudes may affect performance

* Based on an atmospheric pressure of 14.7 psi (101 kPa) at 70°F (21°C)

** Operating outside of these specifications can limit the concentrator's ability to meet Oxygen Concentration specifications at higher liter flow rates.

1.5 FreeStyle 5 Classifications

Type of protection against electric shock:

Class II Protection from electric shock is achieved by double insulation.

Degree of protection against electric shock:

Type BF Equipment providing a particular degree of protection against electric shock regarding

- 1) allowable leakage current;
- 2) reliability of protective earth connection (if present).

Not intended for direct cardiac application.

Independent testing for Medical Electrical Equipment Standard:

Tested to be in compliance with,
IEC 60601-1 Medical Electrical Equipment – Part 1: General Requirements for Safety

Tested to be in compliance with applicable requirements of the Standard,
CAN/CSA C22.2 No. 60601-1-08 M90 Medical Electrical Equipment

Protection against potential electromagnetic or other interference between the equipment and other devices.

Tested to be in compliance with:

EN 60601-1-2 Medical Electrical Equipment, Part 1: General Requirements for Safety-
Collateral Standard: Electrical Compatibility - Requirements and Tests

RTCA/DO160 Airborne Equipment, Sec. 21, Emission of Radio Frequency Energy

CISPR 11 / EN 55011 Class B Group 1, “Industrial, Scientific, and Medical (ISM) Equipment”

FCC Part 15, Subpart B – Class B Unintentional Radiators

Method of cleaning and infection control allowed:

Please refer to “Cleaning, Care, and Proper Maintenance” section of this FreeStyle 5 Patient Manual.

Degree of safety of application in the presence of flammable anesthetic gases:

Equipment not suited for such application.

Mode of operation:

Continuous duty.

2.0 Operation Check and Test of Oxygen Concentration

2.1 Description of Operation

Air enters the FreeStyle 5 Oxygen Concentrator through an external air intake / gross particle filter. This filtered air enters the compressor via a muffler that quiets the compressor's suction sound.

Next, a two-way solenoid feed valve directs the air into one of two sieve beds that contain molecular sieve. The unique property of molecular sieve enables it to physically attract (adsorb) nitrogen when air passes through this material, thereby separating the nitrogen from the oxygen in ambient air.

There are two sieve beds: While one produces high-concentration oxygen, the other is purged of the nitrogen it adsorbed (collected) while it made oxygen.

In addition to the molecular sieve beds that allow oxygen to be separated from air, FreeStyle 5 contains an Oxygen Conserving Device (OCD) valve that controls delivery of high-concentration oxygen to the patient at the point in the breathing cycle when the patient starts to inhale.

FreeStyle 5 delivers a gas consisting of 90% (+5.5 -3%) oxygen at pulse flow rates equivalent from approximately 1–5 LPM.

2.2 Operation Check

AirSep tests every FreeStyle 5 Oxygen Concentrator thoroughly after manufacture. You must perform the following test to ensure that no damage occurred in shipping or handling.

1. Open and inspect all cartons upon delivery. Unpack the unit and remove it from the carton. Inspect the unit itself for damage. If the exterior of a unit's carton is damaged, or if the unit itself is damaged, note this on the freight bill signed by the driver.
2. Connect the power supply to the unit, and turn the unit on by pressing flow setting [5]. Check to see that the following sequence occurs:
 - a. A brief, continuous alarm sounds to indicate that FreeStyle 5 has been turned on.
 - b. The compressor runs.
 - c. After a 10 second start up is complete, the fan turns on.
 - d. Exhaust air flows from the unit.
3. Perform an oxygen concentration test, as described in Section 2.4.

2.3 Alarm System

An audible alarm sounds if FreeStyle 5 has a low battery, senses no inspiration, high temperature, system overdraw, high or low pressure. If an alarm sounds, observe which lights are on. The visual and audible alarm conditions are explained in detail below.

2.3.1 Start-Up

A one-second, audible alarm sounds to indicate start-up. FreeStyle 5 begins to operate when the alarm stops.

2.3.2 Battery Status

To check the level of charge of the internal battery, press the BATT button on FreeStyle 5's keypad. The battery gauge / indicator(s) LEDs above the BATT button illuminate from 25-100% to indicate the level (capacity) of the internal battery. At less than 25% capacity, the 25% LED blinks.

2.3.3 Low Battery

As the battery power approaches a low level, a ½ second beep is emitted every five seconds, and a yellow LED on the battery gauge / indicator(s) will blink for a ½-second every five seconds. When this occurs, the patient is instructed to connect the FreeStyle 5 AC or DC power supply or change to another source of oxygen. The low battery alarm will continue for approximately 2 minutes before FreeStyle 5 stops operating.

2.3.4 Discharged Battery

When the battery is discharged, the unit shuts down. Before this occurs, a ½ second beep sounds every ½ second and the yellow battery LED blinks at the same rate until any one of the 1-5 settings on the keypad are pressed. After the alarm is turned off, connect the FreeStyle 5 unit to its AC or DC power supply or change to another source of oxygen immediately. When the FreeStyle 5 unit is connected to the AC or DC power supply, FreeStyle 5 operates and the internal battery recharges simultaneously.

2.3.5 Battery Charging

To check the level of charge of the battery, press the button on the battery's keypad. The battery gauge/indicator(s) illuminate to indicate the level of battery charge (25-100%).

To charge the FreeStyle 5's internal battery:

- Connect its AC power supply or DC (auto) power supply into the unit's power receptacle located on the right side of the FreeStyle 5 unit, and the other end to its proper AC or DC power outlet. (See Figure 3.1).
- The FreeStyle 5 internal battery will completely charge from a fully depleted state in approximately 3 hours and 15 minutes.



NOTE

Depending upon the temperature of the FreeStyle 5 battery, it can take several minutes for the charging cycle to start after connecting to power. This is a normal condition and is intended for safe charging.

- While charging a fully discharged battery, initially the 25% LED will start blinking rapidly for a few minutes, then start to blink at a slower rate (½ second).
- The LED will continue to blink until a 25% capacity is reached. The LED will then turn solid.
- Each of the four LEDs, 25-100%, will blink as stated above, then turn solid when they reach their capacity.
- Once all LEDs illuminate solid, the battery is fully charged and the LEDs will remain on solid for approximately 1 ½ hours, then all four LEDs will turn off.
- If the AC or DC power supply is not connected, the LEDs will turn off within five seconds.



NOTE

The lithium ion rechargeable battery that is used in the FreeStyle 5 unit does not need to be fully depleted before recharging. It is recommended to charge the battery regardless of the battery's capacity level after use. The battery will charge when the unit is off as well as while the unit is running off the AC or DC power supply.



NOTE

Lithium batteries may permanently lose capacity when exposed to extremely hot temperatures with the batteries fully charged or completely depleted. For extended storage, it is recommended that batteries be charged 25 to 50% and remain within a temperature range of 73°F (23°C).

2.3.6 Battery Fully Charged

When FreeStyle 5 is connected to an AC or DC outlet and is either in operation or is off, the green 100% battery gauge/indicators displays to indicate that the battery is fully charged.

2.3.7 Cannula Disconnect (No inspiration detected)

When FreeStyle 5 is operating and does not sense breathing within 15, consecutive minutes, a constant alarm (beep) sounds, and the yellow alarm light illuminates simultaneously. If this occurs, check the connection from the cannula to the FreeStyle 5 unit, make sure that the nasal cannula is positioned properly on your face, and ensure that you are breathing through your nose. (Your physician may recommend the use of a chin strap if needed.)

If the alarm continues to sound, the patient should change to an alternate source of oxygen and contact the Equipment Provider.

2.3.8 Performance Warning

The performance of FreeStyle 5 can be affected by two conditions.

1) If the user's breathing rate causes the FreeStyle 5 unit's capacity to be exceeded.

The amount of oxygen that FreeStyle 5 supplies is dependent on the flow control switch setting and the breathing rate. If the breathing rate is too fast for the flow selector setting, the capacity of FreeStyle 5 can be exceeded. The patient should reduce activity or consider locating another source of oxygen.

2) The second condition that can result in decreased performance is a general malfunction (i.e. High temperature, High or Low pressure).

If either of these events occurs, an alarm sounds every five seconds. If breathing is too fast for the flow selector setting and FreeStyle 5 capacity is exceeded, the yellow light flashes. If a general malfunction occurs, a continuous red alarm light appears

2.3.9 FreeStyle 5 Capacity Exceeded

When the patient's breathing rate has caused the capacity of FreeStyle 5 to be exceeded, a rapid intermittent beep, beep, beep alarm sounds with an intermittent yellow alarm light. When this occurs, oxygen concentration is outside specifications. The patient should reduce activity, then if necessary use another source of oxygen as available. Contact your Equipment Provider.

2.3.10 General Malfunction

If a general malfunction of the FreeStyle 5 unit occurs, Two ½ second alarms sound every 5 seconds, and the red ALARM light turns on. When this occurs, oxygen concentration is outside specifications. The patient should change to another source of oxygen and contact the Equipment Provider.

2.4 Oxygen Concentration Test and Specification

To ensure that FreeStyle 5's oxygen output is within specification, you must perform an oxygen concentration test. Test the unit upon delivery to a patient and at periodic intervals. Equipment Providers, based upon their own expertise and documentation, may establish and implement their own protocol to check oxygen concentration.

1. Connect the FreeStyle 5 Oxygen Concentrator using an AirSep-supplied AC adapter only (AirSep Part No.PW020-1) to a 100-240 volt, 50/60 Hz electrical outlet.
2. Turn unit on by pressing setting 5 on keypad.
3. Simultaneously press and hold settings 1 and 5 for 10 seconds. After 10 seconds, the alarm will sound and the LEDs above each flow setting will illuminate verifying auto pulse mode.

Control Panel

Flow Settings 1 - 5



Figure 2.1

4. Allow unit to warm-up for 2 minutes before recording oxygen concentration.
5. Connect a calibrated oxygen analyzer to the oxygen outlet and record the unit's concentration. The specification in test mode is 87% or higher.

3.0 Patient Instructions

3.1 General Instructions

It is important that patients thoroughly understand how to operate AirSep's FreeStyle 5 unit. This enables proper treatment as prescribed by a qualified, licensed physician. You must explain that the purpose of this therapy is to alleviate symptoms. If patients experience any discomfort or if the unit alarms, they must notify their Equipment Provider and/or physician immediately.

You, as the Equipment Provider, are responsible to ensure that each patient receives the *FreeStyle 5 Patient Manual*. Explain each step in the operation of the unit to the patient with reference to the patient manual.

3.1.1 Connecting to External Power

When connecting the AC or DC power supply to the FreeStyle 5 unit, be certain to first properly align the power cord to this inlet. To do this, take note of the "D"-shaped plug of both the power cord connector and the FreeStyle 5's inlet connection. These must be aligned, and the button on the power cord must be pressed in for removal. This ensures that neither the unit nor the power accessories are damaged.

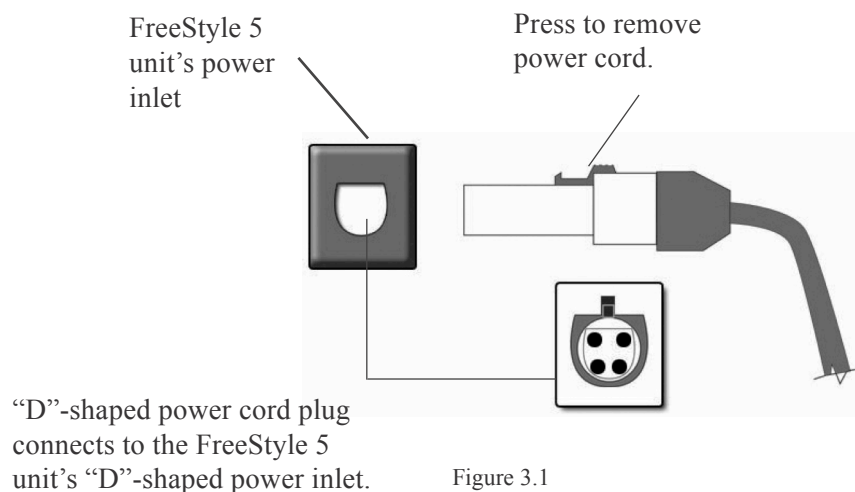

3.1.2 Optional AirBelt™ Battery

Instruct patients that connecting an optional AirBelt to the unit by inserting the power into the unit's power inlet provides additional total run time, per the specifications. Note that the unit battery must still have a charge remaining before the external AirBelt is connected. The patient should be advised to not fully deplete the unit battery as a small amount of power is needed to engage the AirBelt.

To charge the AirBelt battery:

- 1) Release safetycap from end of the AirBelt cord.



The incorrect use of AirBelt can cause it to get hot, ignite, and may cause serious injury. Be sure not to pierce, strike, step on, or drop the battery, or otherwise subject the battery to strong impacts or shocks.

2. Connect the AC/DC power supply (included with the AirBelt Accessory kit) to the end of AirBelts power cord as shown in Figure 3.2.
3. Connect the AirBelt power supply to an AC electrical outlet to recharge.

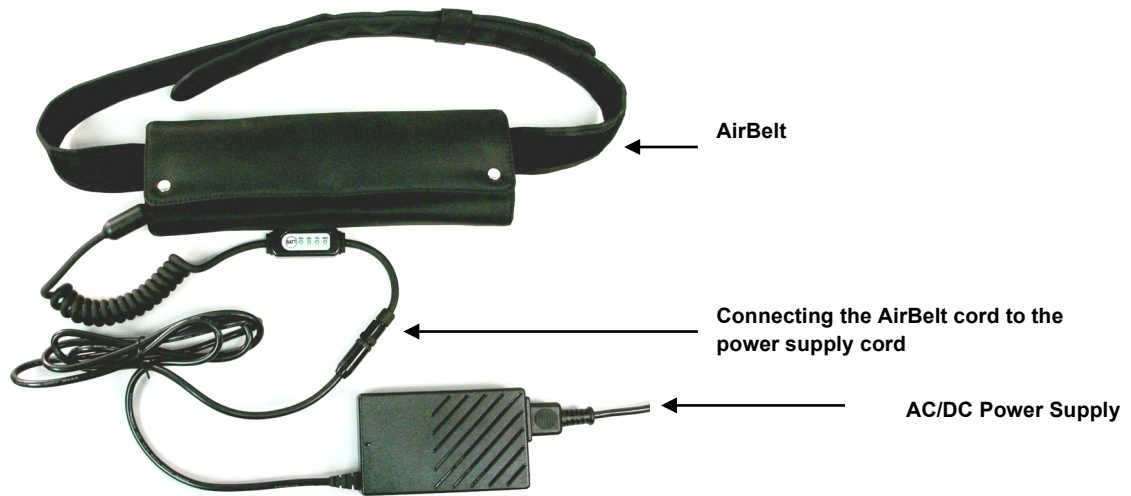

Figure 3.2: AirBelt Battery Charging set up



Replace safety cap on AirBelt cord when not in use.



Do not attempt to charge the optional AirBelt with the any other power supply or the AirBelt can be damaged. Use only the AirBelt power supply provided to charge AirBelt.

- The FreeStyle 5 AirBelt will completely recharge from its fully depleted state in approximately 3 ½ hours.
- While charging a fully discharged battery, the LED will continue to blink until 25% capacity is reached. The LED will then turn solid.
- Each of the four LEDs, 25% -100%, will blink as stated above, then turn solid when the battery reaches it's capacity.
- When all LEDs illuminate solid, the battery is fully charged and the LEDs will remain solid for a period of time, then all four LEDs will turn off.



Lithium batteries may permanently lose capacity when exposed to extremely hot temperatures with the batteries fully charged or completely depleted. For extended storage, it is recommended that batteries be charged 25 to 50% and remain within a temperature range of 73°F (23°C) +/- 2°C.



Depending upon the temperature of the AirBelt battery, it can take several minutes for the charging cycle to start after connecting to power. This is a normal condition and is intended for safe charging.



AirBelt does not need to be fully discharged before recharging. It is recommended to charge it after each use.



If the AirBelt power supply remains connected when it is fully charged, the four LEDs will turn off within ½ hour.

3.2 Routine Maintenance by the Patient

To ensure accurate output and efficient operation of the unit, the patient must perform two simple, routine maintenance tasks:

- Clean the air intake / gross particle filter
- Contact the Equipment Provider for inspection/service when an alarm indicator illuminates.

3.2.1 Cleaning the Air Intake / Gross Particle Filter



The patient must clean this filter weekly, as described below. The filter may require daily cleaning if the FreeStyle 5 unit operates in a harsh environment, for example, a house heated by wood, kerosene, or oil, or one with excessive cigarette smoke.

1. The air intake / gross particle filter can be found on the lower front of the FreeStyle 5, as seen in the photo below.



**Air Intake /Gross
Particle Filter
Cover**

Figure 3.2

2. Pull the filter cover off the front of the FreeStyle 5 and remove the filter. Wash filter in a warm water and soap solution.
3. Rinse the filter thoroughly, and remove excess water with a soft, absorbent towel. Ensure that the filter is dry before replacing it.
4. Replace the dry filter into the filter cover.
5. Place the filter cover back into housing and push back onto the FreeStyle 5 unit.

3.2.3 Nasal Cannula

AirSep recommends a nasal cannula with 7 ft (2.1 m) of tubing, AirSep Part No. CU002-1 or suitable cannula. Other lengths of non-kinking / star channel cannula can be used for a total length of up to 25 ft (7.6 m) maximum.

3.2.4 Usage During Sleep

AirSep recommends that FreeStyle 5 should be used while sleeping only under the direction of their clinician. In addition, some patients who mouth-breathe may benefit from the use of a chin strap



NOTE

Always follow the cannula manufacturer's instructions for proper use. Consult your licensed health care provider to determine how often the cannula should be replaced.



NOTE

Cannula tubing must be non-kinking, which can be used for a total length of up to 25ft (7.6cm) maximum.



NOTE

Ensure the cannula is fully inserted and secure. This ensures that the FreeStyle 5 unit can properly detect inspiration for oxygen delivery.

4.0 Equipment Provider Maintenance

4.1 No Scheduled Maintenance

FreeStyle model units are maintenance-free due to their technologically advanced design. AirSep does not require preventative maintenance or service on these concentrators as long as the concentrator remains within specifications. To ensure that the unit's output of oxygen is within specification, you must establish and implement a protocol to check oxygen concentration upon delivery to a patient and at periodic intervals (Refer to Section 2.4 of this manual).

4.1.1 Air Intake / Gross Particle Filter

The external air intake gross particle filter is located in the air intake/filter cover. You can easily remove it by hand. Instruct the patient to clean this filter weekly. (Refer to Section 3.2.1, "Cleaning the Air Intake / Gross Particle Filter," of this manual.)



The filter may require more frequent cleaning if the FreeStyle 5 unit operates in a harsh environment — a house heated by wood, kerosene, or oil, or one with excessive cooking or cigarette smoke.

4.1.2 Product Filter Replacement

The product filter must be replaced after every 10,000 hours of use.

Product Filter/Volume Tank Replacement

1. Turn unit off and disconnect the power cord.
2. Remove the back housing, and locate the product filter/volume tank.
(See Figure A-3.)
3. Disconnect tubing from the inlet of the product filter/volume tank.
4. Unscrew the product filter/volume tank from the product manifold.
5. Place the o-ring into the o-ring groove located on top of the volume tank.
6. Fasten the new product filter/volume tank to the product manifold.
7. Connect the tubing and secure with a tie-wrap.

4.1.3 Compressor Servicing

As the Equipment Provider, you are responsible for monitoring the life of the compressor, which must be checked at every 5,000 hours of use.

4.1.4 Recording Maintenance

As the Equipment Provider, you should record all routine maintenance and repairs performed on the FreeStyle 5 unit, including hours and dates of service.

4.2 Infection Control

With growing concern about possible cross infection from home oxygen equipment from one home care patient to another, a clarification on this topic is necessary. The organisms of most concern are M. Tuberculosis, HIV, and Viral Hepatitis. These are potentially pathogenic.

Tuberculosis can survive outside the human body, but its mode of transmission is by droplet nuclei. When infected individuals cough, they release droplet nuclei into the air, and these carry the Tuberculosis organism. These droplet nuclei may be breathed in by another person, but prolonged exposure to the infected person is usually necessary for infection to occur.

HIV and Viral Hepatitis are both viruses that are not living cells themselves but can duplicate when in a living “host” cell. Both of these organisms are usually passed on by person-to-person contact, and both need to be in the human body to survive. Once outside the body, viruses do not survive.

4.3 Cleaning and Preparing for New Patient Use

When you remove FreeStyle 5 from a patient’s home, always detach and dispose of the used nasal cannula. Clean the exterior of FreeStyle 5 with a mild household cleaner applied with a damp cloth or sponge. Pay special attention to the oxygen outlet for the cannula connection to make sure it remains free of dust, water, and particles. Be careful not to get any liquid into the interior of the unit.

Next, clean the exterior with a common chemical disinfectant before any other patient uses the unit. Do not use liquid directly on the FreeStyle 5 unit to clean it.



Do not use liquid directly on the FreeStyle 5 unit to clean it. A list of **undesirable** chemical agents includes but is not limited to, the following, according to the plastics manufacturer: alcohol and alcohol-based products, concentrated chlorine-based products (ethylene chloride), and oil-based products (Pine-Sol, Lestoil). These are NOT to be used to clean the plastic housing on FreeStyle 5, they can damage the units plastic.

Clean or replace the air intake / gross particle filter with warm soapy water between each patient's use. The patients should be instructed to clean this filter at least once per week, depending on the environment, during normal operation.

Change the felt filter after 5,000 hours of use.

Change the product filter after 10,000 hours of use. It is not necessary to change this filter between patients even if the previous patient had a communicable disease or infection.

Allow FreeStyle 5 to air dry, and then re-test oxygen concentration before you return the unit to your inventory.

*Make the bleach solution a 1:100 dilution of 5.25% sodium hypochlorite. Mix one part household bleach (e.g., Clorox with 99 parts cold tap water). To measure the solution easily, take 1/4 cup of household bleach, and mix it with a gallon of cold tap water. Allow the mixture to sit on potentially contaminated surfaces for 10 minutes.



AirSep does not recommend the sterilization of this equipment.

5.0 Service

5.1 Components

The design of AirSep's FreeStyle 5 Portable Oxygen Concentrator allows for easy access and removal of most components. This allows you to perform scheduled maintenance and to repair and replace parts with minimal time and effort.



For your safety, be sure to disconnect the FreeStyle 5 Universal AC / DC adaptor from the power outlet before you service the concentrator.



Note all scheduled maintenance. (Refer to Section 4.0 of this manual.)

5.2 Housing Removal

5.2.1 Removing Front Cover

1. Place unit on its back and position the outlet nozzle upwards facing forward.
2. Locate the three screws securing the front cover (top center, lower left, and right).
3. Using a Phillips-head screwdriver, loosen, and remove the screws.
(See Figure 5.1.)



Figure 5.1

4. Lift off the front cover.

5.2.2 Removing Back Cover

1. Place unit on its front.
2. Locate the four screws securing the back cover.
3. Using a Phillips-head screwdriver, loosen and remove the screws.
4. Lift off back cover.



Figure 5.2

5.3 Internal Battery Replacement



When removing the front cover to remove the battery, always use ESD safeguard to protect the electronic circuit board from damage.

1. Remove the front housing.
2. Carefully disconnect the 8-pin (J12) and 2-pin (J14) connector from the battery pack to the circuit board. (See Figures 5.3 and 5.4.)



Figure 5.3

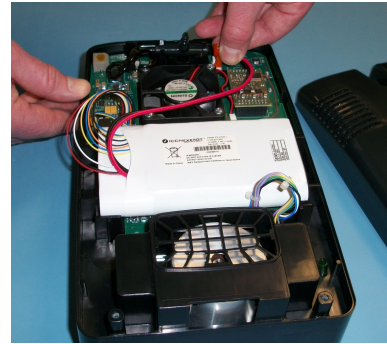

Figure 5.4

3. The battery pack is fastened using Velcro. To remove the pack, simply pull on battery. (See Figure 5.5.)

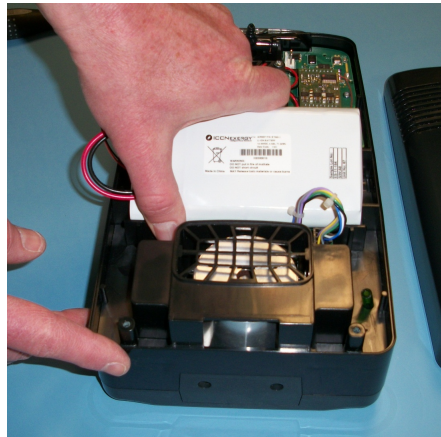

Figure 5.5

4. Take new battery pack with the wire harnesses to the left, and press firmly into the battery cradle. Gently pull on battery to ensure the Velcro has engaged.
5. Connect the 8-pin (J12) and 2 pin (J14) connector in their respective connectors on the circuit board.



When the battery is disconnect and reconnected to the FreeStyle 5, it will not power the unit until it is initialized by connecting FreeStyle to external power.

6. Place front housing back on and fasten.
7. Plug the FreeStyle 5 AC or DC power supply to initialize and charge battery.

5.4 PSA Removal

1. Disconnect the FreeStyle 5 unit from the AC or DC outlet.
2. Remove the front housing.
3. Remove the battery. Care must be taken when removing (J12) and (J14) connector.
4. Disconnect the 8-pin connector (J17) with multi-color wires from the circuit board. Care must be taken not to pull on wires. (See Figure 5.6.)



Figure 5.6

5. Remove and discard foam from the top of the oval opening. (See Figure 5.7.)

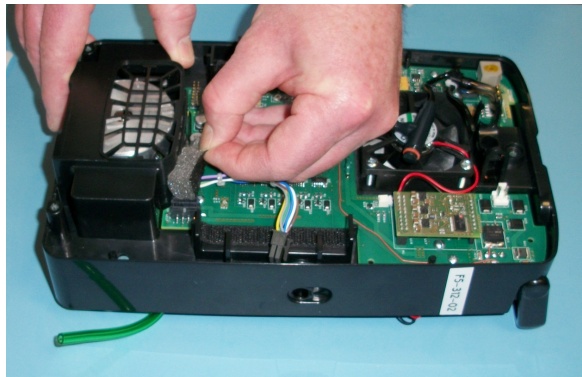

Figure 5.7



The following two steps (6 and 7) require extreme caution to ensure the black pressure sensor (U9) is not damaged.

6. Remove the adjustable nozzle by gently pulling it upward until it comes out of the left side retaining clips. When the left side is out, pull the nozzle to the left to completely remove it from its cradle. (See Figure 5.8.)



Figure 5.8

7. Carefully disconnect the 1/8" OD tubing coming from the back of the unit to the limiting orifice. (See Figure 5.9.)

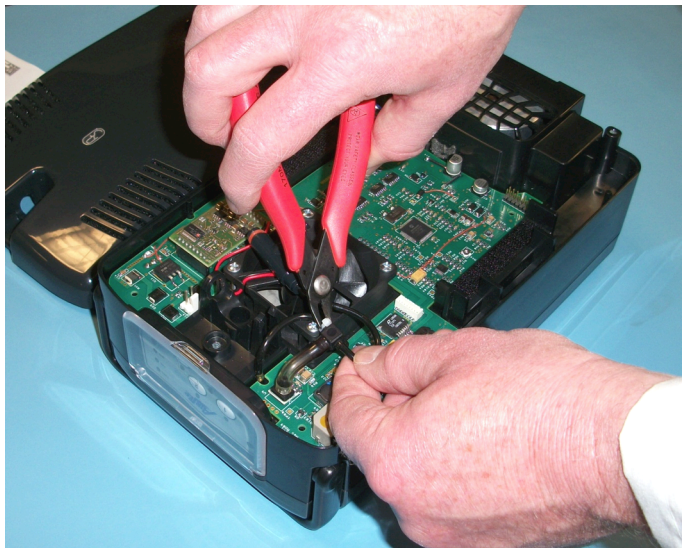

Figure 5.9

8. Remove the 8-32 x 1/4" black Phillips screws located in the center of outlet nozzle cradle. (See Figure 5.10)

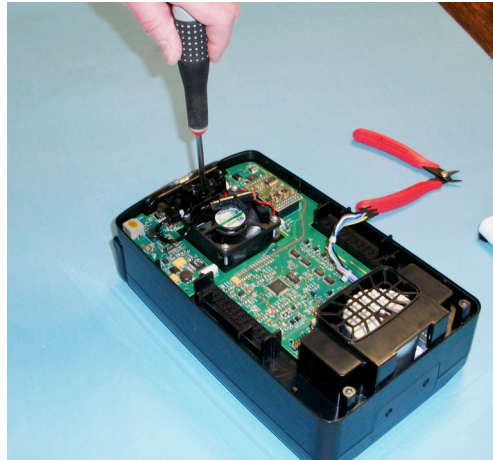

Figure 5.10

9. Turn unit over and remove the back housing.



Figure 5.11

10. Disconnect the 1/8" OD tube from the Y-connector or T connector (which is located at the back of the PSA system) that connects to the pressure transducer on the left side.

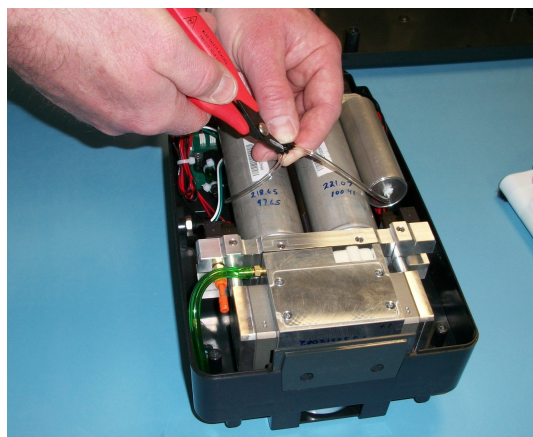

Figure 5.12

11. Using needle nose pliers, disconnect all the valves from the circuit board, carefully noting where each valve is connected. Do not disconnect by pulling on the wires. (See Figure 5.13 and 5.14.)

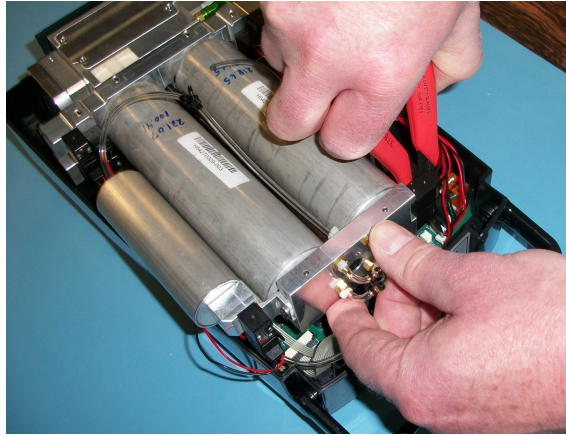

Figure 5.13

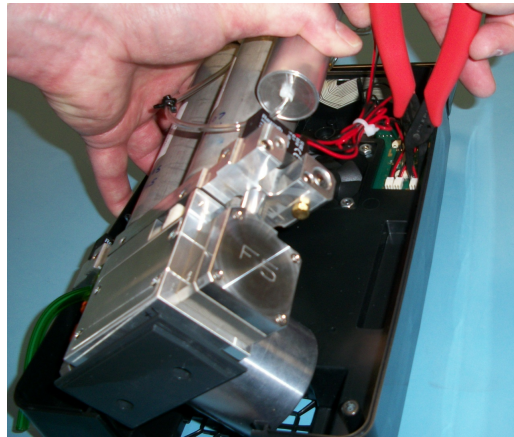

Figure 5.14

12. Carefully remove the complete PSA assembly from the center housing by pulling it upwards and slipping compressor mox connector through center section. (See Figure 5.15.)

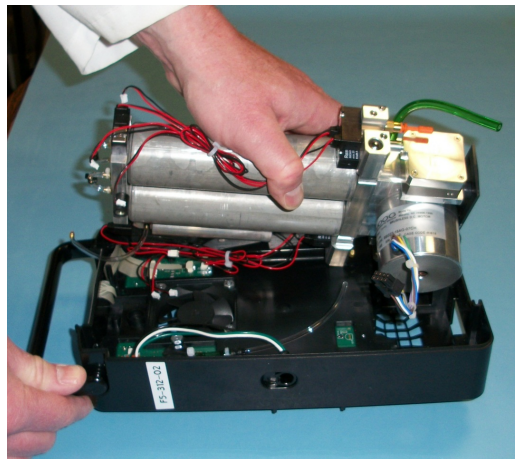

Figure 5.15

13. Remove the compressor plate by removing the two screws. (See Figure 5.16.)

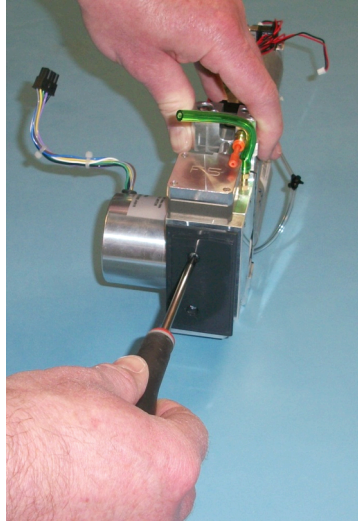

Figure 5.16

14. Remove the two mounts from the compressor. (See Figure 5.17.)

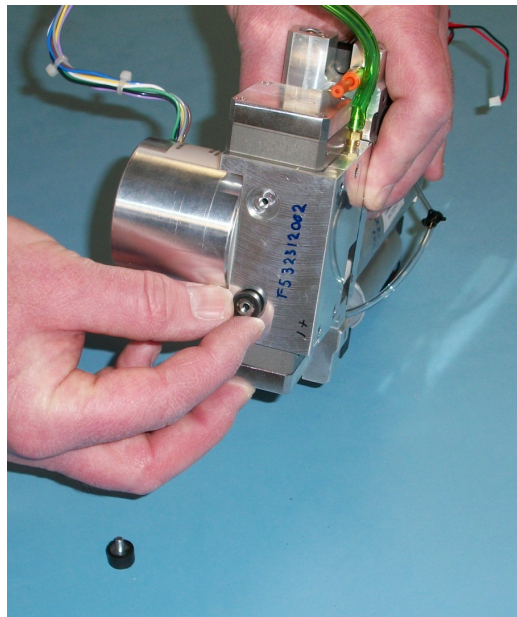

Figure 5.17

5.5 Compressor Replacement

The compressor is the “pump” within the oxygen concentrator that pushes room air into the bottom of the sieve beds. This allows oxygen to flow out the top.

Over time, the cup seals wear and the compressor does not operate properly.

5.5.1 Compressor Assembly Removal

1. Remove PSA system assembly per Section 5.4.
2. Stand the PSA assembly upright and loosen the center bolt using a 5/32” Allen wrench. (See Figure 5.18.)

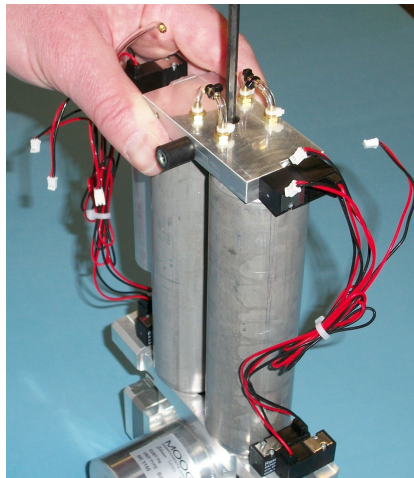

Figure 5.18

2. Remove the compressor by pulling the compressor away from the PSA assembly. Care should be taken not to separate manifold from beds. (See Figure 5.19)

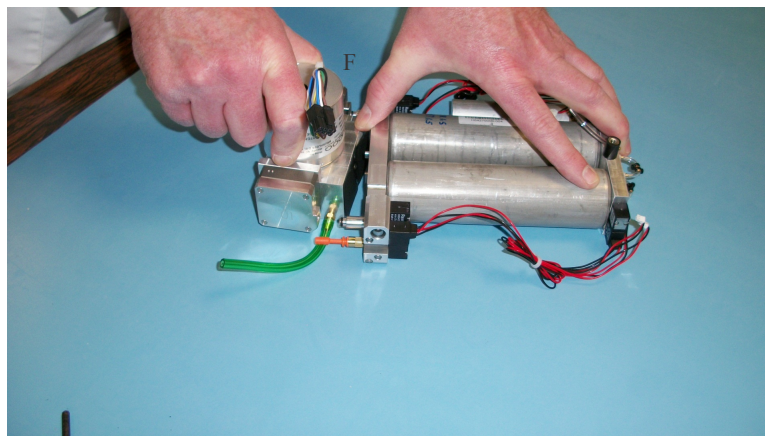

Figure 5.19

4. If either of the two fittings connecting the compressor to the manifold is connected to the compressor, remove it and insert it into the manifold. (See Figure 5.20.)

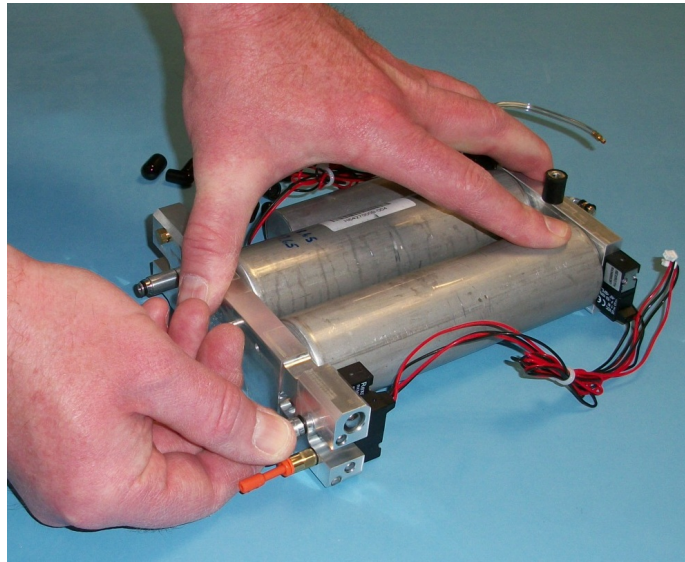

Figure 5.20

5. Connect the new compressor to the PSA assembly, and tighten the bolt to a torque of 15 in-lbs. (See Figure 5.21.) Be sure the gasket is in place.

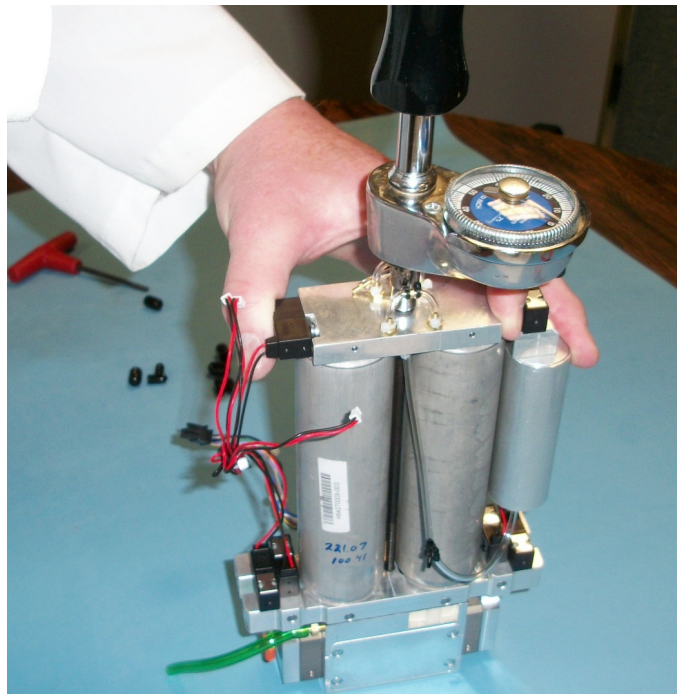

Figure 5.21

5.5.2 Compressor Assembly Installation

To install the new compressor assembly, perform the compressor removal procedure in reverse order.



After replacing the unit's compressor, you must reset the hour meter.
(Refer to instructions for reading and recording hours in the CD Kit P/N KI406-1)

5.6 Product Manifold Replacement

1. Remove the PSA system per Section 5.4.
2. Disconnect the tubing from the barb on the product manifold.

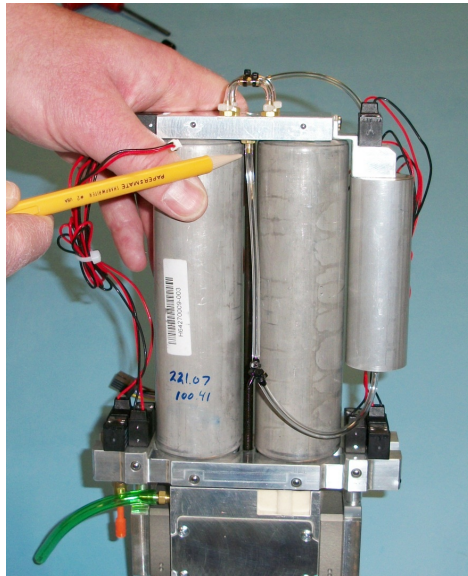

Figure 5.22

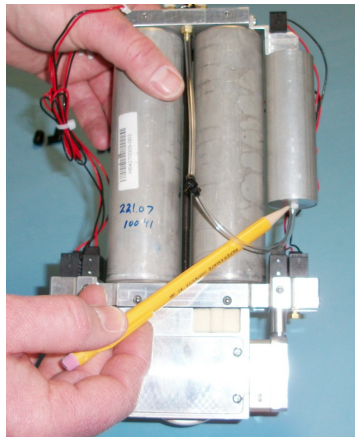

Figure 5.23

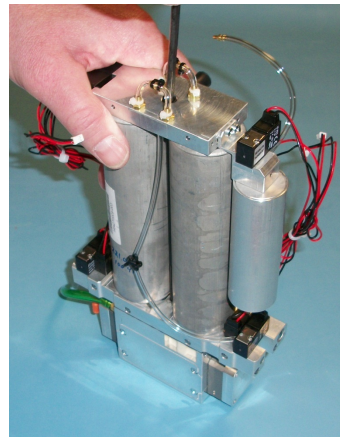

Figure 5.24

3. Remove the tie wraps that bundle the solenoid valve wire together.

4. Loosen and remove the center bolt from the PSA assembly using a 5/32" Allen wrench.

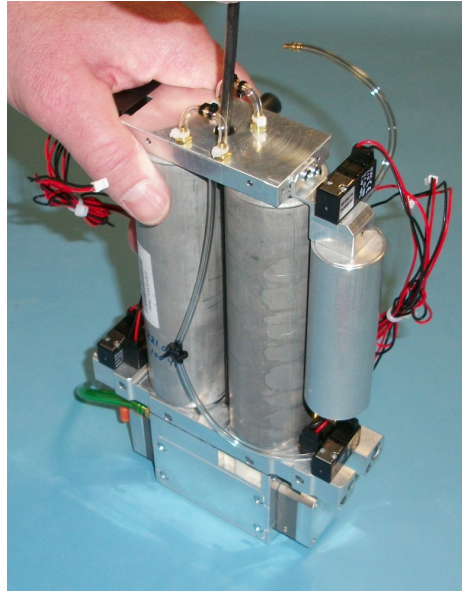

Figure 5.25

5. Holding sieve beds in place, gently pull upward on the product manifold to remove. Keep tubing assembly in place.
6. Align new product manifold with the outlet of the sieve beds, and gently push manifold down into place.
7. Reconnect tubing to new product manifold.
8. Place center bolt through product manifold and tighten to 15 in-lbs.

5.7 Solenoid Valve Replacement

1. Remove back cover panel per Section 5.2.2.
2. Determine which valves need to be replaced.
3. Remove the tie-wraps that bundle the valve wires.
4. Carefully disconnect the Molex connector from the circuit board by pulling on the Molex connector, not the valve wire.
5. Using a small Phillips screwdriver, remove the two screws fastening the valve.
6. Remove the valve.
7. Verify two o-ring seals are installed on the new valve.
8. Fasten new valve using the two screws provided.
9. Re-bundle wires and tie-wrap.
10. Start FreeStyle 5 unit and leak test around the area where the o-rings are located on the valve.



NOTE

It may not be necessary to completely remove the PSA system assembly to replace the solenoid valve. The Feed B/Waste B OCD valve will require the PSA system to be partially removed.

5.8 Adsorbent Bed Replacement

1. Remove the PSA system assembly per Section 5.4.
2. Loosen and remove the center bolt from the PSA system assembly using a 5/32" Allen wrench.
3. While holding the adsorbent beds, gently pull up on the product manifold to remove from top of product manifold.



Figure 5.26

4. Pull upward on the adsorbent beds to remove from the feed/waste manifold.

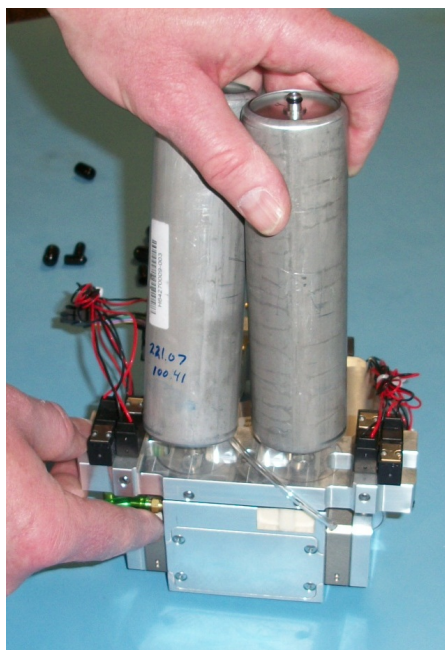

Figure 5.27

5. Remove the plugs from the top and bottom of the new adsorbent beds.
6. Place a 1.5 mm CS X 6 mm ID o-ring on the bottom cap of the adsorbent bed cap.
7. Place a 1.5 mm CS X 3.5 mm ID o-ring on the top cap of the adsorbent beds.
8. Align product manifold with the outlet on the new adsorbent beds and gently push down until the o-rings are completely seated.
9. Place center bolt through product manifold and tighten to 15 in-lbs.

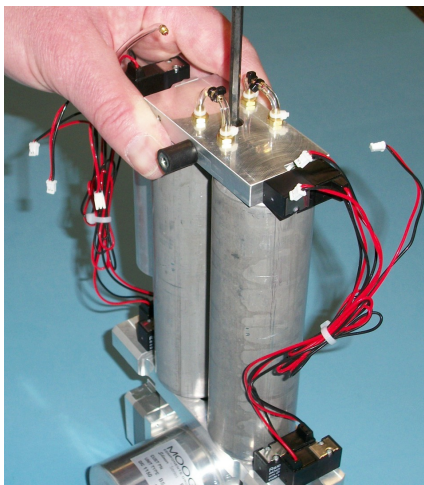

Figure 5.28

10. Reassemble FreeStyle 5, and leak test at bed connections

5.9 Feed/Waste Manifold Replacement

1. Remove PSA system per Section 5.4.
2. Carefully remove tie-wraps that bundle the solenoid valve wires together.
3. Loosen and remove the center bolt from the PSA assembly using a 5/32" Allen wrench.
4. Holding both sieve beds, gently pull upward, removing the product manifold and sieve beds. Set product manifold and sieve bed assembly aside, keeping top of sieve bed connected to product the product manifold.

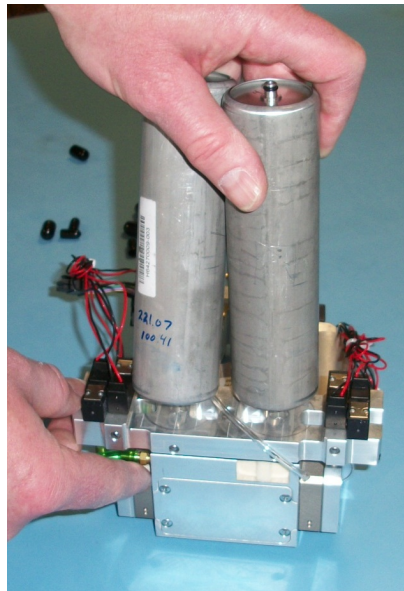

Figure 5.29

5. Remove feed/waste manifold by pulling upward on the manifold. Both fittings from the manifold to the compressor should still be connected to the manifold. If not, remove fitting(s) from the compressor.
6. Place new feed/waste manifold onto compressor. Gently push manifold down until compressor fittings are seated into compressor head.

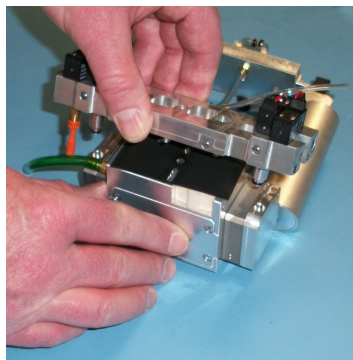

Figure 5.30

5.10 Measuring System Pressure

1. Remove the back cover.
2. Locate the brass fitting with the orange plug on the left side of the feed/waste manifold.
3. Remove the plug.
4. Using the pressure gauge with 1/8" OD tubing, push tube into the fitting.
5. Turn the unit on in the [2] setting.
6. Make sure that the connection front the pressure gauge to the manifold is leak-free. Part No. K1036-1 Pressure Test Kit (gauge and connector) and KI340-1 Adaptor.
7. Put unit into test mode by pressing [1] and [5] simultaneously for 10 seconds. After 10 seconds, the alarm will sound and the LEDs above each flow setting will illuminate. The unit will then start to automatically pulse in flow setting [5].

Reference Section 6.1 Pressure Profiles

5.11 Circuit Board Replacement



When replacing the circuit board, always use and ESD safe work area. Also, use an ESD wrist strap to protect electronic circuitry.

1. Remove front and rear cover as per Section 5.2.
2. Remove internal battery per Section 5.3 Internal Battery Replacement.
3. Remove PSA system as per Section 5.4.
4. Remove DC power input connector from location J13, pin 3 connector on circuit board.

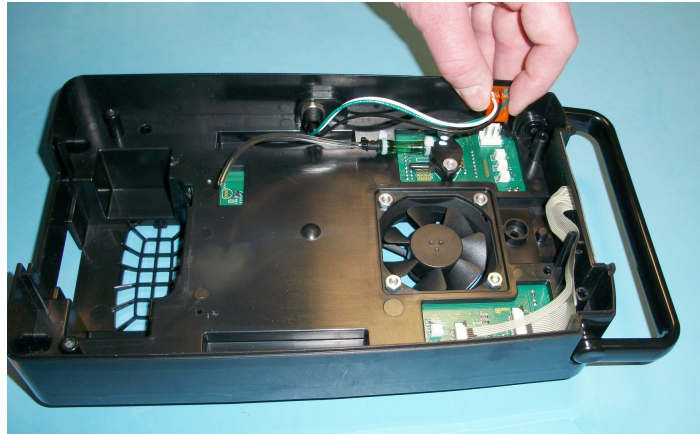

Figure 5.31

5. Disconnect control panel/keypad flex circuit from J9 & 10 Ziff (zero insertion force) connector by carefully lifting upward on the locking tab.

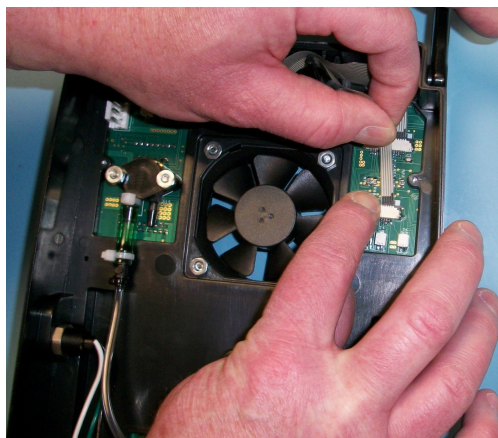

Figure 5.32

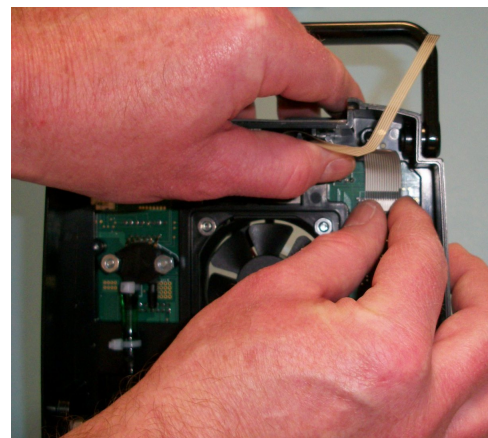

Figure 5.33

6. Turn unit over so that the main circuit board is facing up.
7. Remove motor controller board as per Section 5.12.
8. Remove cannula nozzle tubing by cutting tie-wrap (use small-size cutter). Carefully pull tubing from nozzle barb.

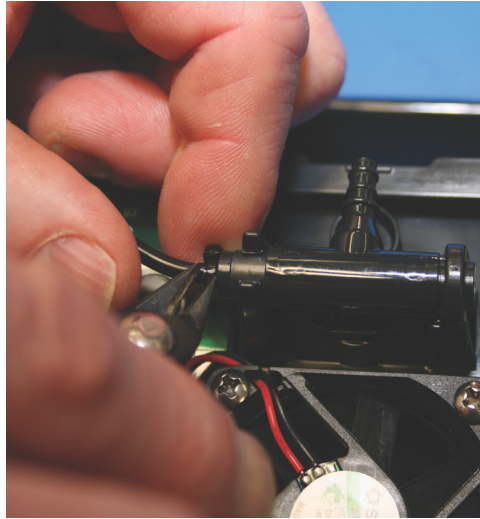

Figure 5.34

9. Disconnect fan connector using needle-nose pliers, carefully pulling upward on fan connector housing at location J15 on main circuit board.

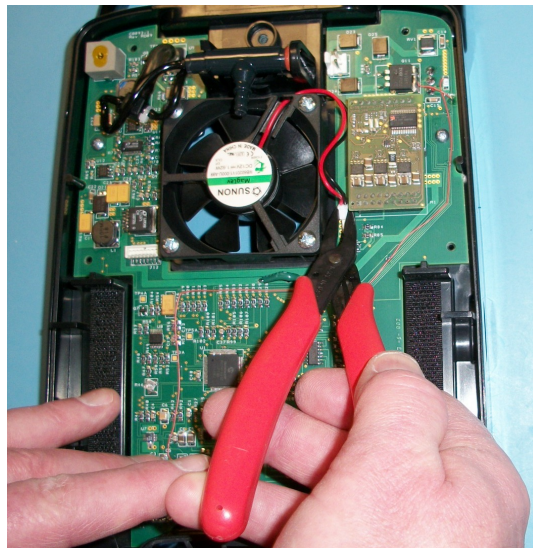

Figure 5.35

10. Remove eight 4-20 self-tapping screws.



Figure 5.36

11. Remove main circuit board from center section assembly.

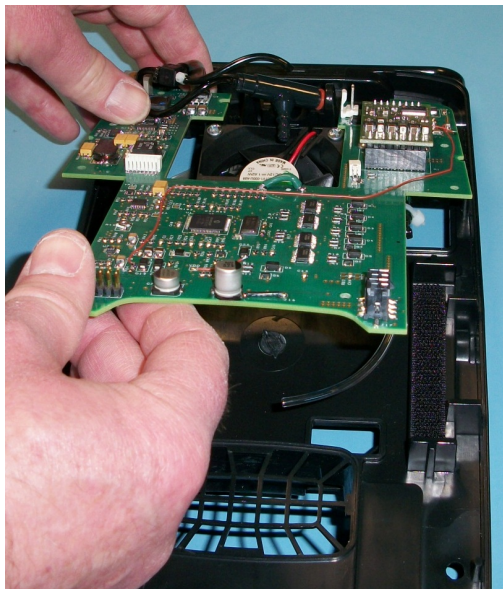

Figure 5.37

12. Replace main circuit board; reverse order of steps 1-12

5.12 Motor Controller Board Replacement



When replacing the motor controller circuit board, always use an ESD safe work area. Also, use an ESD wrist strap to protect electronic circuitry.

1. Lift the motor controller board from the circuit board, being careful not to break the connector pins while gently rocking it back and forth to loosen and disconnect.

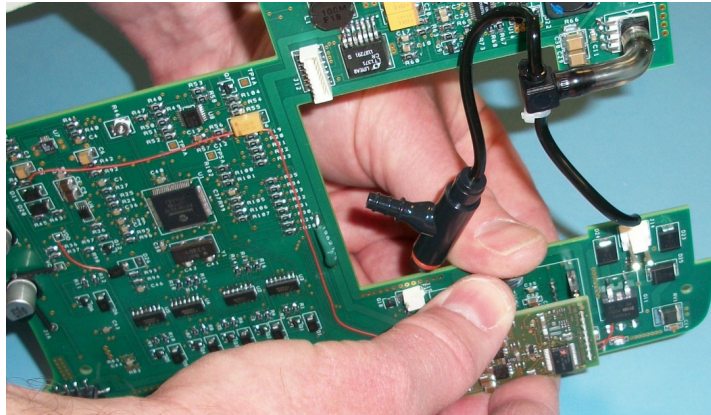

Figure 5.38

2. Before replacing the board, ensure that the main circuit board and all pins are straight and unbroken (intact).
3. Locate the side with the single row connector. Install on the circuit board with the single row connector facing the top of the unit.

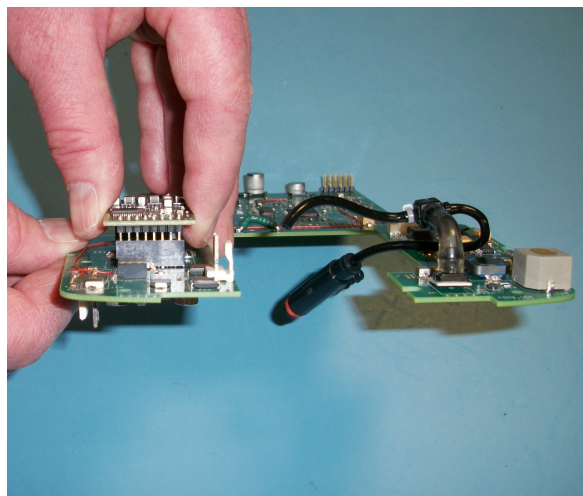

Figure 5.39

4. Following alignment, view the replacement board from the side at an angle to make certain that the pins are aligned properly before seating the connector.

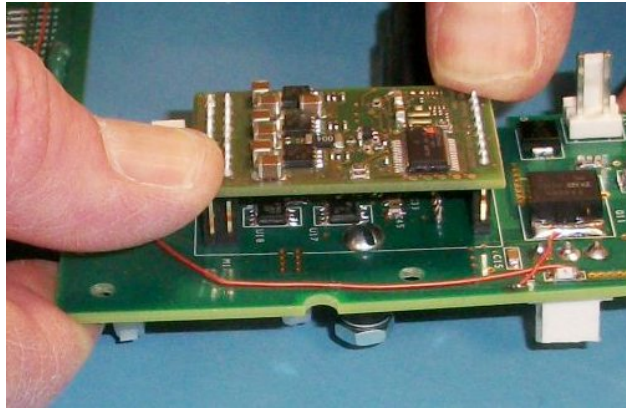

Figure 5.40

5. Gently press the board into place until properly seated

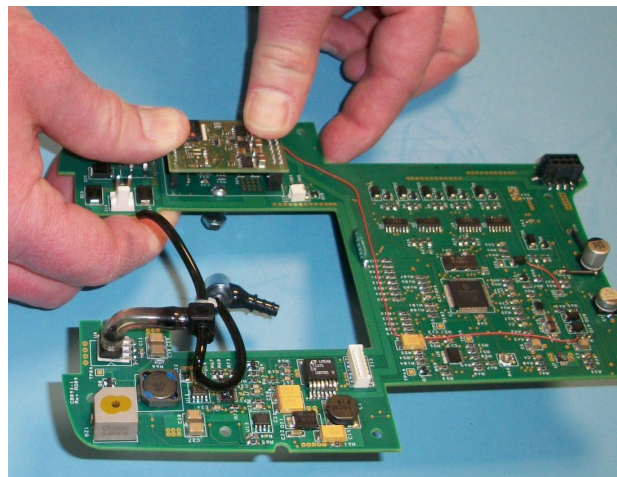

Figure 5.41

5.13 Control Panel/Key Pad Replacement



When replacing the control panel keypad, always use and ESD safe work area. Also, use an ESD wrist strap to protect electronic circuitry.

1. Remove the front and rear cover per Section 5.2.
2. Remove PSA system per Section 5.4.
3. Remove control panel/keypad flex circuit from J9 & 10 Ziff (zero insertion force) connectors by carefully lifting upward on locking tab.
4. Remove the flex tab circuit from rib guides, and peel off the control panel/keypad from the center enclosure.

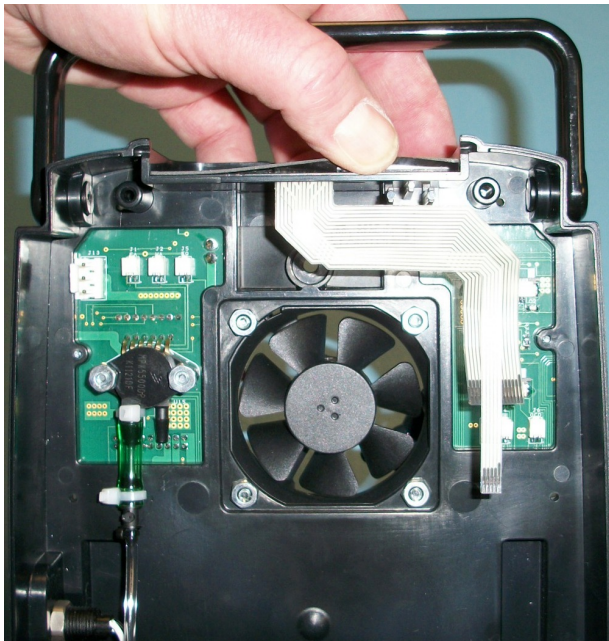

Figure 5.42

5. Replace control panel/keypad with new control panel keypad.
6. Check control recessed area of enclosure center section to ensure plastic is clean and all adhesive backing and seal backing from new control panel keypad.

7. Remove adhesive backing and seal backing from new control panel/keypad.

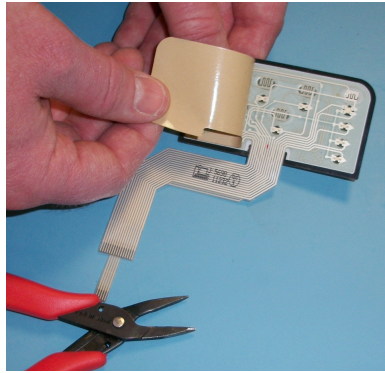

Figure 5.43

8. Carefully align control/keypad to enclosure recessed control panel area, and press keypad evenly to ensure all adhesive is in contact with plastic surface.



Figure 5.44

9. Route the flex circuit from control panel keypad notched area of control panel enclosure section.

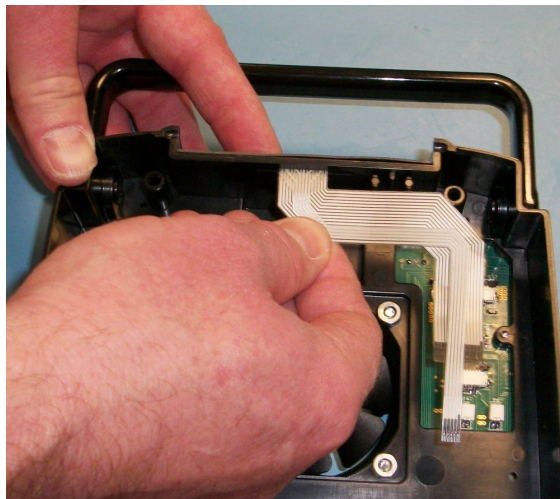

Figure 5.45

10. Bend flex circuit 180°, being careful not to crease or fold the flex circuit.



If creased or folded, the flex circuit will be damaged

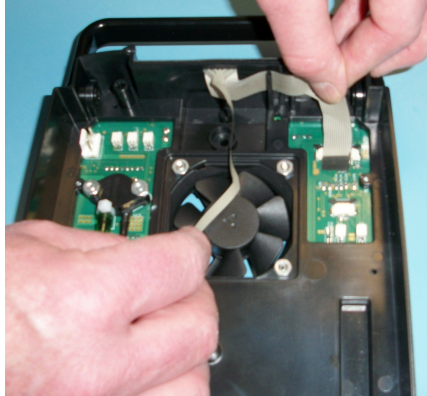

Figure 5.46

11. Insert flex circuit into rib section and connect flex circuit with carbon contacts facing toward you.
12. Insert into J9 & 10 Ziff (zero insertion force) connectors, making sure that the flex circuit seats into the connectors. Carefully press the Ziff connector locking tabs in a downward direction. Ensure latch seats.

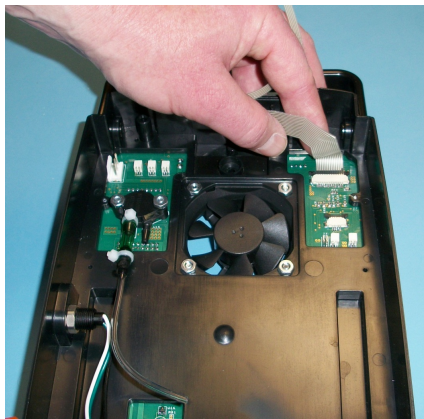

Figure 5.47

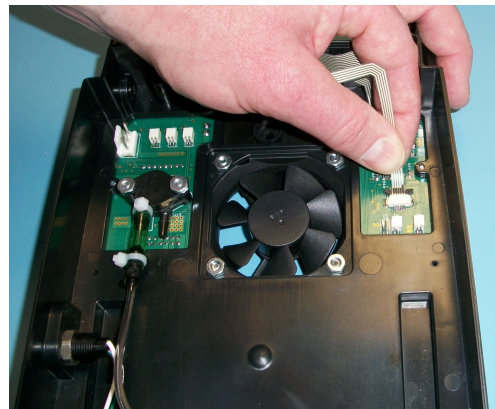

Figure 5.48

13. Replace PSA system.

5.14 Fan Replacement



When replacing the fan, always use and ESD safe work area. Also, use an ESD wrist strap to protect electronic circuitry.

1. Remove PSA system assembly per Section 5.4.
2. Remove internal battery per Section 5.3.
3. Disconnect the Molex connector (J15) from the circuit board to the fan.

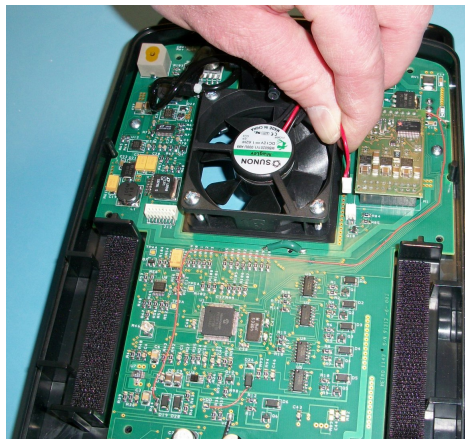

Figure 5.49

4. Remove the four Phillips screws securing the fan to the center section.



Figure 5.50

5. When installing the new fan, be sure the arrow on the side of the fan is pointing outwards toward the front cover. This arrow indicates the direction of the airflow of the fan. Be sure the two wires coming from the fan are located on the upper right side.

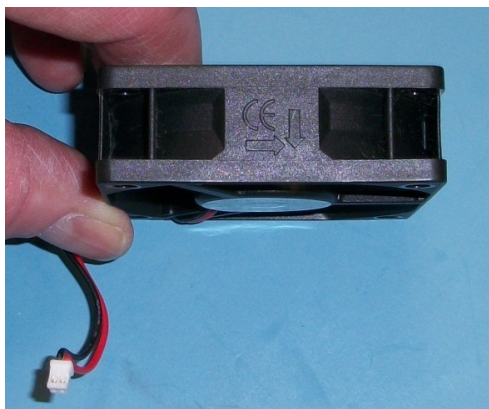

Figure 5.51

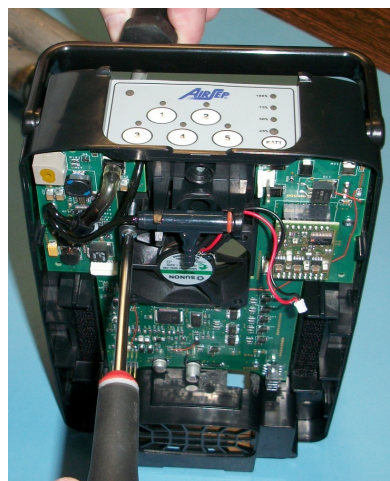

Figure 5.52

6. Insert screws through each of the four corners of the fan. Secure with kep nut. **Do not over tighten.**
7. Connect Molex connector (J15) to the circuit board.

6.0 Pressure Profiles

6.1 Pressure Profile Quadrant

The following pressure profiles illustrate the range of normal operating pressure at sea level. These are approximate pressures. A unit may be out of the range shown below and still be within specification, for example, in higher altitude environments.

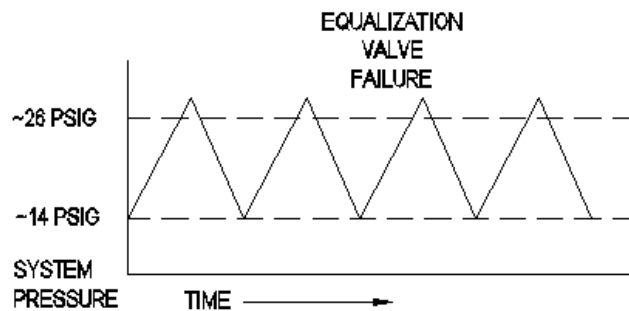
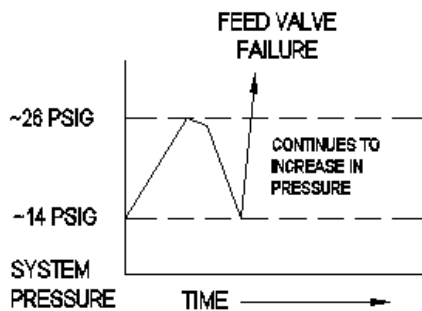
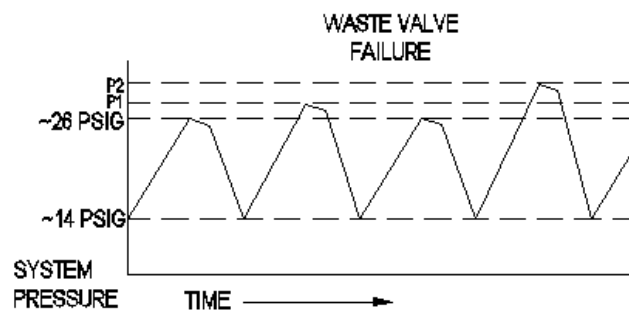
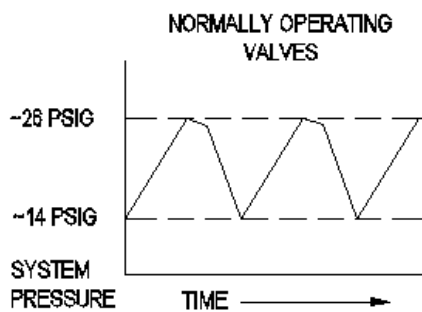

7.0 Troubleshooting

7.1 General Troubleshooting

Before reviewing the Troubleshooting Chart, the following steps may be useful to isolate any malfunctions:

1. Make sure all filters are clean.
2. Turn the unit on by pressing flow setting [5]. A brief, continuous alarm sounds to indicate that the FreeStyle 5 has been turned on. The compressor will start to run, you must wait 10 seconds before proceeding to step 3.
3. Activate the test mode by pressing flow settings [1] and [5] simultaneously for 10 seconds.
4. Make sure that the unit is leak-free by testing all tubing connections and fittings with leak-testing solution. Protect the circuit board from solution, and start the leak test at the compressor, following the air flow of the unit to the oxygen outlet. Repair all leaks by tightening connections and fittings.
5. After five minutes, measure the oxygen concentration.
6. Review the Troubleshooting Chart that follows to isolate and repair any other malfunctions.

7.2 Troubleshooting Chart

Problem	Possible Cause	Solution
Unit does not turn on, and AC power supply is properly connected to a wall outlet.	<p>Wall switch power is off.</p> <p>No power to unit.</p> <p>AC power supply is not properly connected to FreeStyle 5.</p> <p>Defective AC power supply.</p>	<p>Turn on wall or outlet switch.</p> <p>Reset household circuit breaker.</p> <p>Check connection from the AC adapter to FreeStyle 5.</p> <p>Replace AC adapter.</p>
Unit does not turn on, and DC power supply is properly connected to an automobile, RV, accessory outlet.	<p>No power at DC outlet.</p> <p>DC power supply is not connected to accessory outlet or not connected to FreeStyle 5.</p> <p>FreeStyle 5 DC power inlet connector not properly connected to circuit board. Check harness.</p> <p>Defective DC power supply</p> <p>Bad connection at keypad control connector</p> <p>Defective keypad control panel membrane switch.</p> <p>Defective motor controller.</p> <p>Defective circuit board.</p>	<p>Check fuse for DC outlet.</p> <p>Connect DC power supply to outlet of automobile after ignition is started.</p> <p>Replace FreeStyle 5 DC inlet harness; connect harness to circuit board.</p> <p>Replace power supply.</p> <p>Check keypad connection</p> <p>Replace keypad control panel membrane switch.</p> <p>Replace motor controller.</p> <p>Replace circuit board.</p>
General malfunction; alarm is activated.	<p>Unit overheats and will shut down. Check air inlet and exhaust vents for obstruction. Also check inlet filter.</p> <p>Check for leaks.</p> <p>Restricted inlet filter.</p> <p>Compressor failure.</p>	<p>Clear obstructed area of air inlet and exhaust or replace dirty filter. Replace fan if not operating.</p> <p>Correct any leaks.</p> <p>Replace inlet filter.</p> <p>Replace compressor.</p>

Problem	Possible Cause	Solution
<p>Battery duration is less than per specification.</p> <p>Note: While charging, battery may not initiate a charge. Allow unit battery time to drop to operating temperature before charging. Will initiate in approx. (20 min).</p> <p>Note: Whenever storing FreeStyle 5 for an extended period of time, ensure that the battery the state of charge (SOC) is not depleted or stored at 100%. Both these conditions can result in unrecoverable capacity loss. The recommend SOC is 25% to 50% for long-term storage. The recommended storage temperature is 23° C ± 2° C.</p>	<p>Battery not fully charged.</p> <p>Battery has been stored in a discharged or 100% charged state for prolonged period of time or stored in a very high temperature environment.</p> <p>Battery reached cycle life.</p>	<p>Ensure that battery charges for at least 3½ hours and all (4) LEDs are lit solid.</p> <p>Replace battery.</p> <p>Replace battery.</p>
<p>Unit does not start on battery.</p>	<p>Unit temperature has exceeded battery operating temperature 5 to 40°C.</p> <p>Battery reached cycle life Battery is defective</p>	<p>Allow unit to cool before starting.</p> <p>Replace battery.</p>
<p>Battery does not charge.</p>	<p>Unit temperature has exceeded battery operating temperature 5 to 40°C.</p> <p>Battery is defective.</p> <p>AC adapter connector is defective or contact pin is bent.</p> <p>Defective AC adapter</p>	<p>Allow battery to cool before charging.</p> <p>Replace battery</p> <p>Replace battery.</p> <p>Replace AC adapter.</p>

Problem	Possible Cause	Solution
Oxygen concentration is below specifications in test mode.	<p>Unit's temperature is too high. Blocked air intake or outlet; or defective fan.</p> <p>Leak</p> <p>Restriction in exhaust felt.</p> <p>Compressor has reached its expected life.</p> <p>Contaminated absorbent beds.</p> <p>Defective solenoid valve.</p>	<p>Clear any obstruction in air intake or outlet filter; or replace fan as needed.</p> <p>Correct any leaks.</p> <p>Replace exhaust filter.</p> <p>Replace compressor.</p> <p>Replace absorbent beds.</p> <p>Replace manifold or solenoid valve.</p>
Unit does not deliver oxygen.	<p>Cannula kinked or not properly connected.</p> <p>FreeStyle 5 is not turned on.</p> <p>Battery is dead.</p> <p>Defective AC or DC power supply.</p> <p>OCD sensor defective.</p> <p>OCD solenoid valve defective.</p>	<p>Check cannula and the cannula connection.</p> <p>Turn FreeStyle 5 on to the prescribed setting.</p> <p>Replace battery.</p> <p>Replace AC or DC power supply.</p> <p>Replace FreeStyle 5 main circuit board.</p> <p>Replace product manifold or OCD defective valve.</p>
Unit continuously flows oxygen (instead of pulse flow delivery).	<p>Defective OCD valve and volume tank.</p>	<p>Replace product manifold.</p>

8.0 Recommended Tools

8.1 Tools for FreeStyle 5 Service and Maintenance

In addition to a pressure test gauge, the following tools are generally readily available for purchase in your local area, and can assist you in servicing and maintaining the FreeStyle 5 unit.



Figure 8.1a
.25-inch hexnut screwdriver
and Phillips-head screwdriver



Figure 8.1b
5/32-inch Allen-head driver



Figure 8.1c
0-50 lb torque driver
or fixed 15 lb torque driver



Figure 8.1d
needle nose pliers and side cutters



Figure 8.1e
tie-wrap gun

Figure 8.2
Pressure test gauge

Available from AirSep:

Part No. K1036-1 --Pressure Test Kit (gauge and connector) and KI340-1 (adapter)



Appendix

■ Exploded Drawings

Figure 1: FreeStyle 5 — Internal Front View	A-1
Figure 2: FreeStyle 5 — Internal Rear View - Exploded	A-2
Figure 3: FreeStyle 5 — PSA Assembly - Exploded	A-3
Figure 4: FreeStyle 5 — PSA Assembly – Valves Identification	A-4

ITEM	PART NUMBER	DESCRIPTION
1	BT021-1	BATTERY, ASSY, PACK
2	CA296-1	CABINET, SUB-ASSY, HOUSING, CENTER
3	F0589-1	FITTING, NOZZLE, ASSY
4	FO139-1	FOAM, COMPRESSOR, WIRING

ITEM	PART NUMBER	DESCRIPTION
5	OR029-1	O-RING, -009, SILICONE
6	SC063-2	SCREW, PNH, PHIL, 8-32, 1/4" LG.
7	TW011-1	TIE WRAP, NYLON, 2.83 LG.

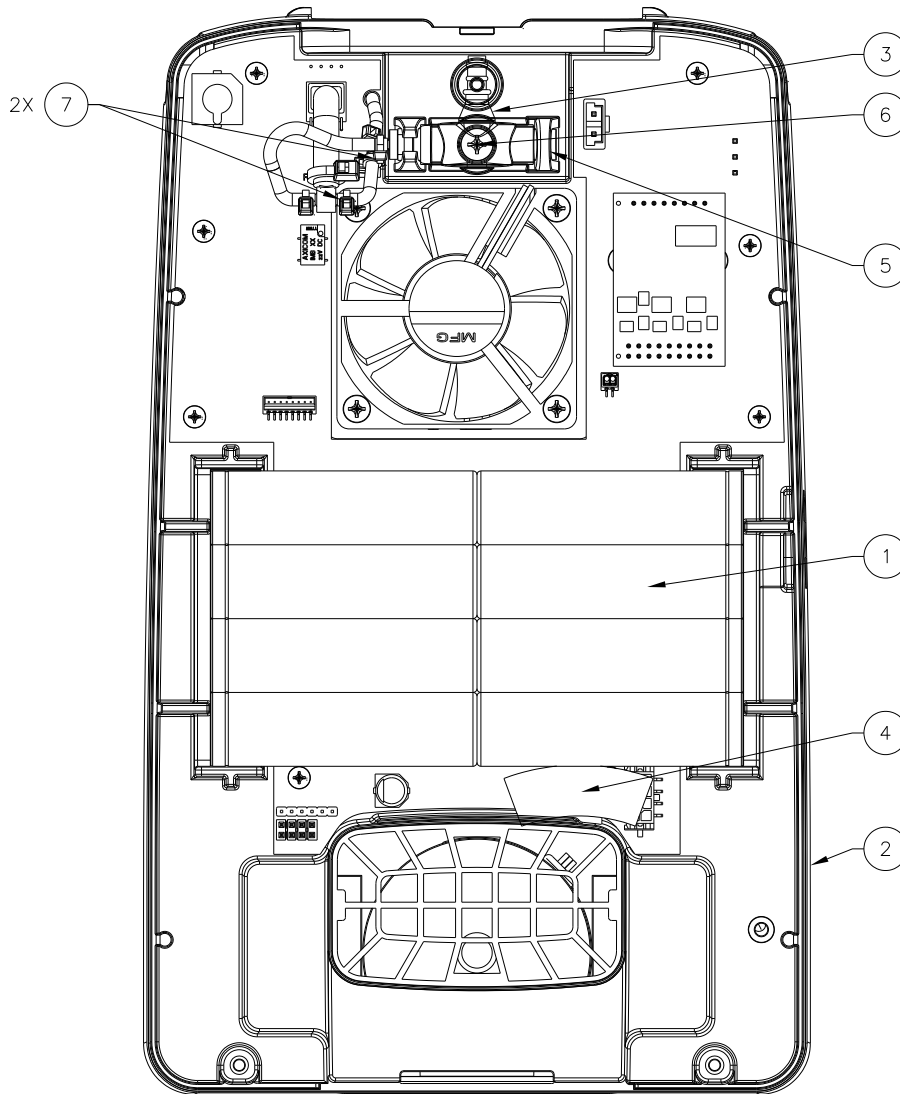

Figure A.1: Internal Front View

ITEM	PART NUMBER	DESCRIPTION
1	CA295-1	CABINET, HOUSING, CENTER
2	CB115-1	CIRCUIT BOARD, ASSY, MAIN, TUBING
3	CB134-1	CIRCUIT BOARD, MOTOR CONTROLLER
4	CN089-1	CONNECTOR, RECEPTACLE, 3-PIN, .156 PITCH
5	CP157-1	CONTROL PANEL, KEYPAD w/ RIBBON
6	FA029-3	FASTENER, VELCRO, HOOKS

ITEM	PART NUMBER	DESCRIPTION
7	FN038-1	FAN, ASSY
8	GS030-1	GASKET, NOZZLE
9	NU003-1	NUT, STEEL, HEX, KEP, 6-32
10	SC002-1	SCREW, PNH, PHIL, 6-32, 1.0" LG
11	SC037-3	SCREW, PNH, PHIL, PLASTITE, 4-20, 1/4" LG
12	WH101-2	WIRE HARNESS, DC INPUT PLUG

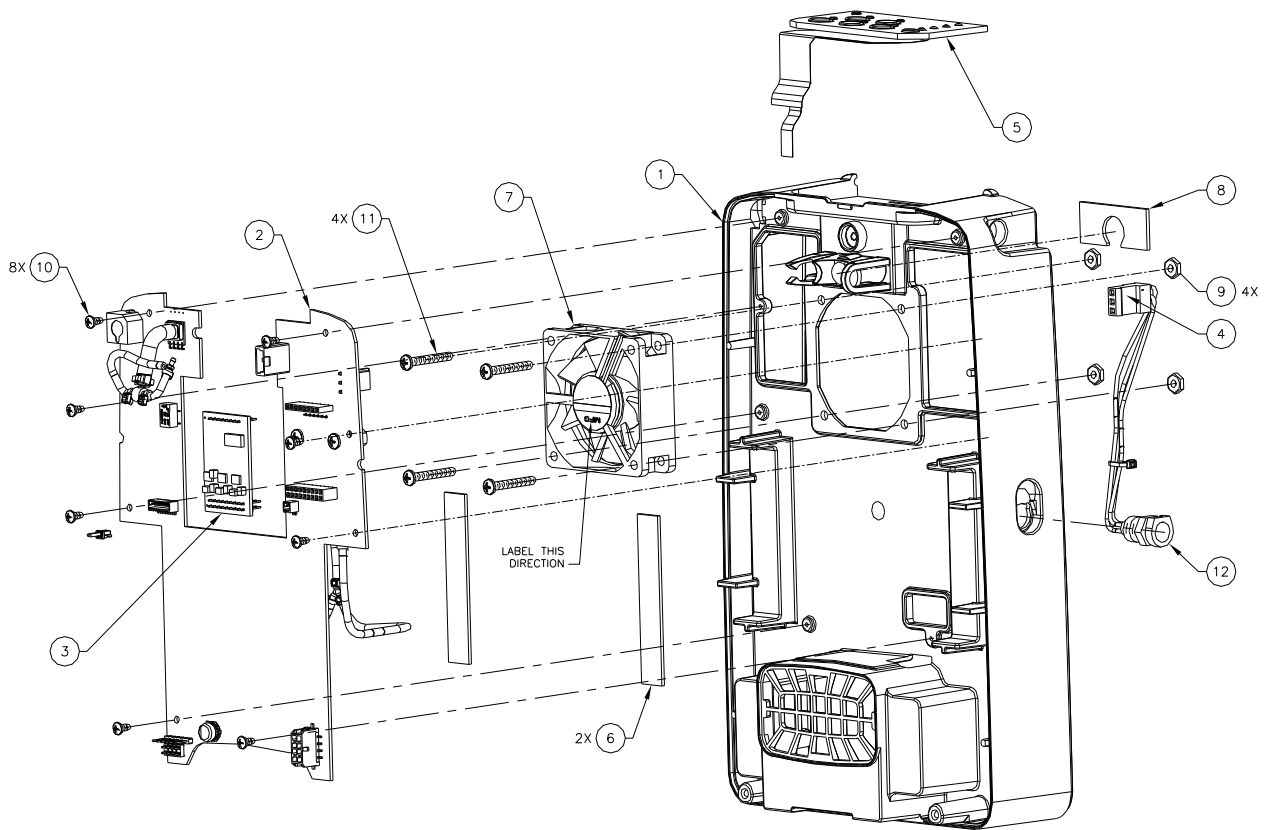

Figure A.2: Internal Rear View - Exploded

ITEM	PART NUMBER	DESCRIPTION
1	BE214-1	BEDS, ASSY, MULTIPLE, 1.62" BED OD
2	CA232-1	CABINET, COMPRESSOR, MOUNTING PLATE
3	CO386-1	COMPRESSOR, ASSY, 1.252" BORE
4	F0593-1	FITTING, COMPRESSOR
5	GS024-1	GASKET, NITRILE, COMPRESSOR/FW MANIFOLD
6	MA215-1	MANIFOLD, ASSY, PRODUCT
7	MA216-1	MANIFOLD, ASSY, FEED/WASTE
8	OR025-3	O-RING, -008
9	OR026-1	O-RING, 1.0mm CS, 8.0mm ID

ITEM	PART NUMBER	DESCRIPTION
10	OR027-1	O-RING, 1.5mm ID, 3.5mm ID
11	OR027-2	O-RING, 1.5mm ID, 6.0mm ID
12	OR028-1	O-RING, .045" CS, .167" ID
13	SC002-4	SCREW, PNH, PHILLIPS, 6-32, 1/4" LG
14	SC105-2	SCREW, CAP, SOCKET HD, HEX, 10-32, 7" LG
15	TA155-1	TANK, VOLUME, ASSY, 1.125" OD
16	TU202-1	TUBING, ASSY,
17	TW011-1	TIE WRAP, NYLON, 2.83" LG, 0.065 W, BLACK

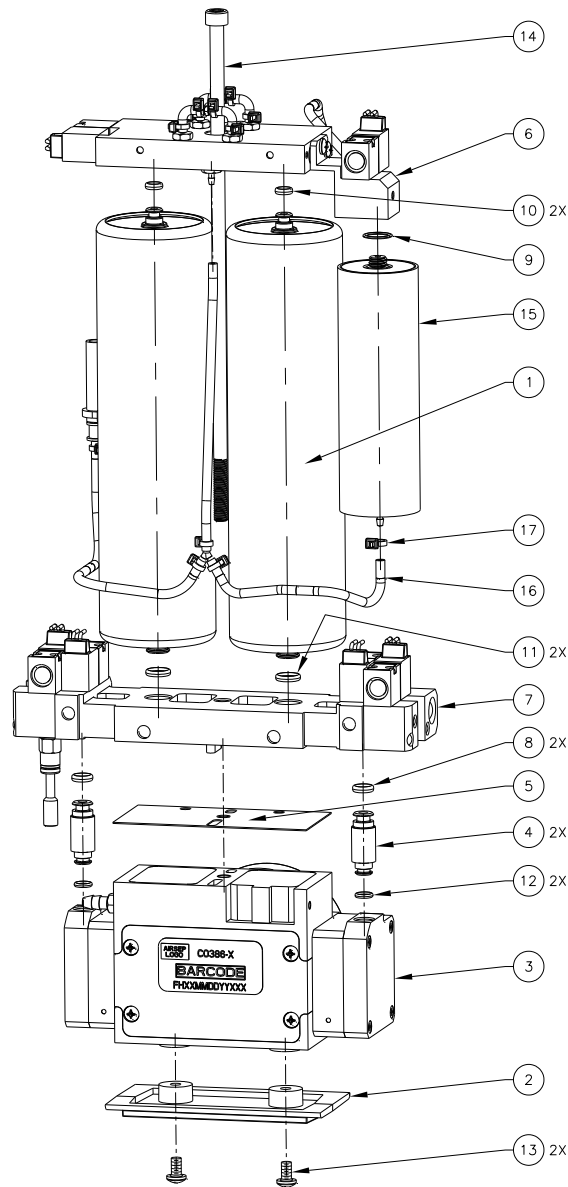

Figure A.3: PSA Assembly - Exploded

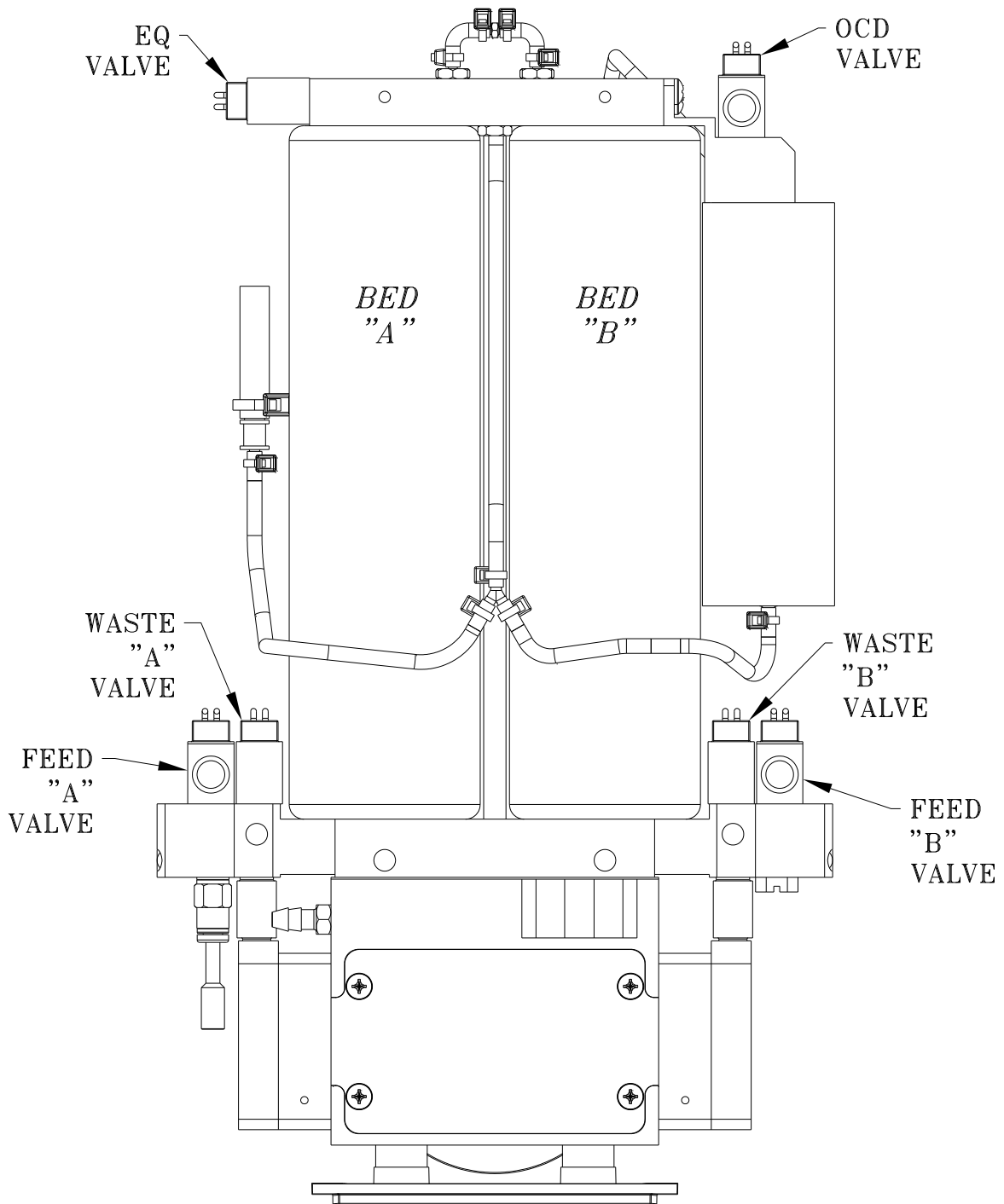

Figure A.4: PSA Assembly – Valves Identification